

- Zeichnungsbereich nach DIN ISO 15724, Maßstab: 2:1 -

ABPH 600

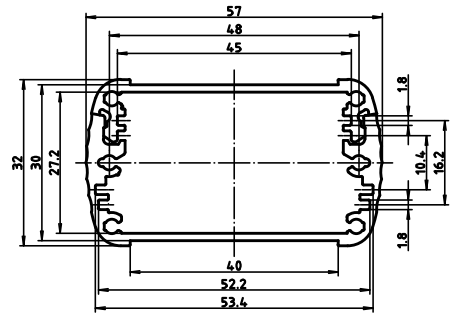

ABPH 820

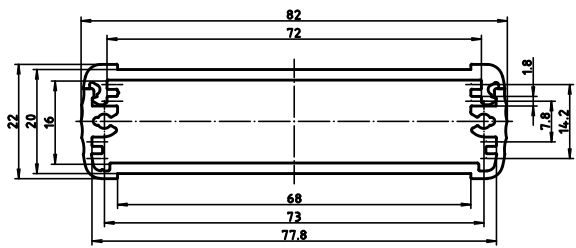

ABPH 800

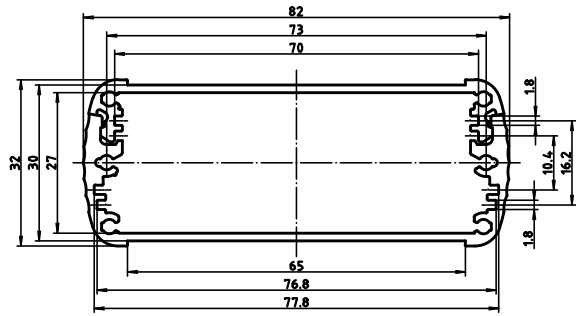

ABPH 1000

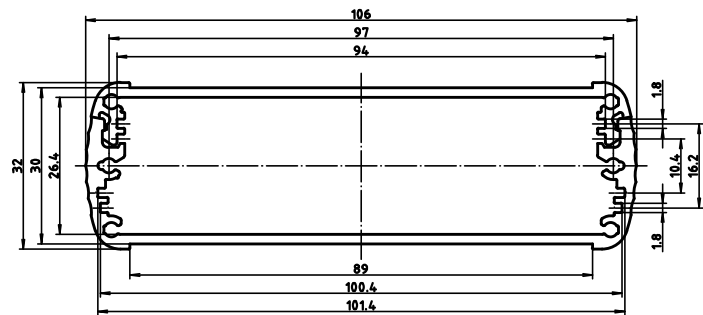

ABPH 1680

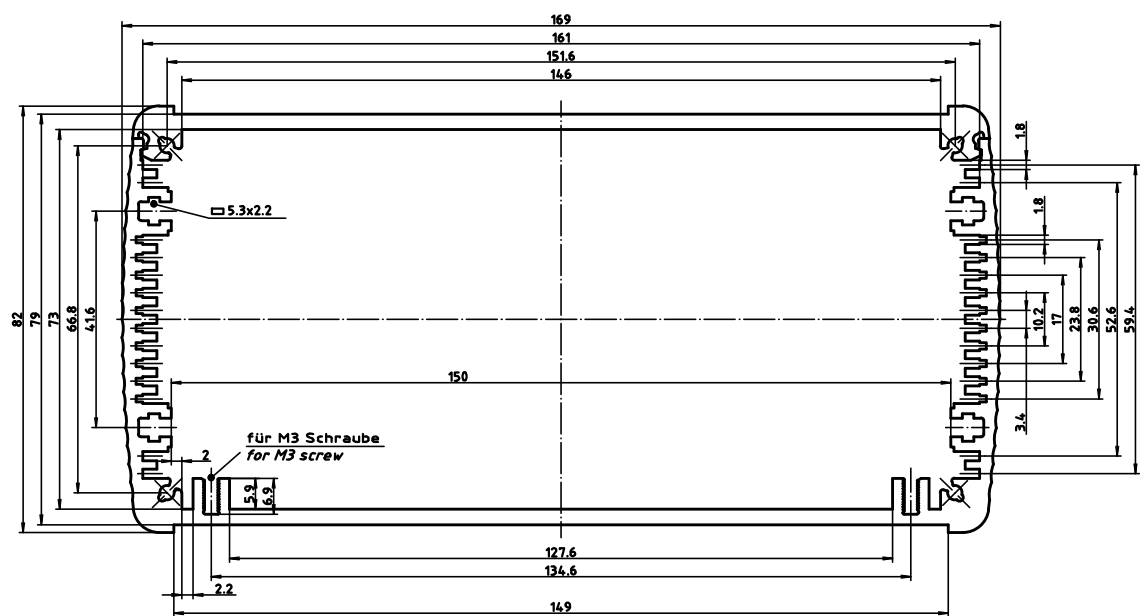

ABPH 1300

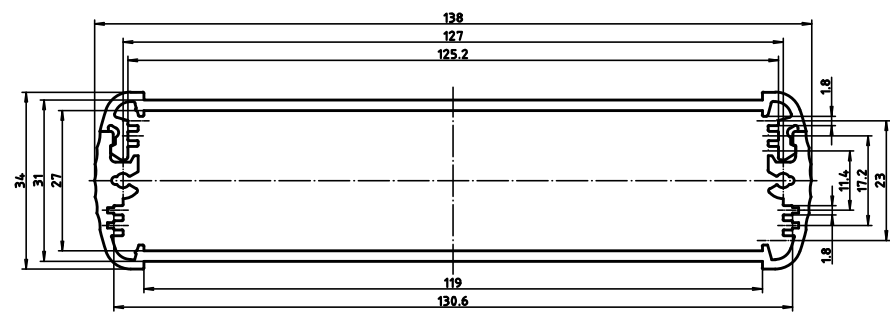

ABPH 1040

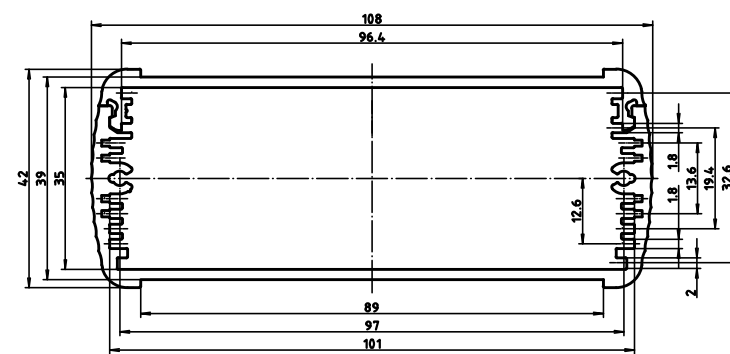

Maßstab/ Scale:	2:1	
Zeichnungs-Nr. / Drawing-No.:	1K 5205.368.01	
Artikel / Article:	ALUBOS	
ABPH ...		
Katalogzeichnung / Catalogue drawing		
		
DISK:	2 802 048	
Datum / Date:	16.05.2020 DR	