

* = Mass durch Formkonizität
nach unten verringert.
Freimaß-Toleranz nach
DIN 16901-130/
*Dimension reduced at
bottom due to conical form.
Tolerances to DIN 16901-130.*

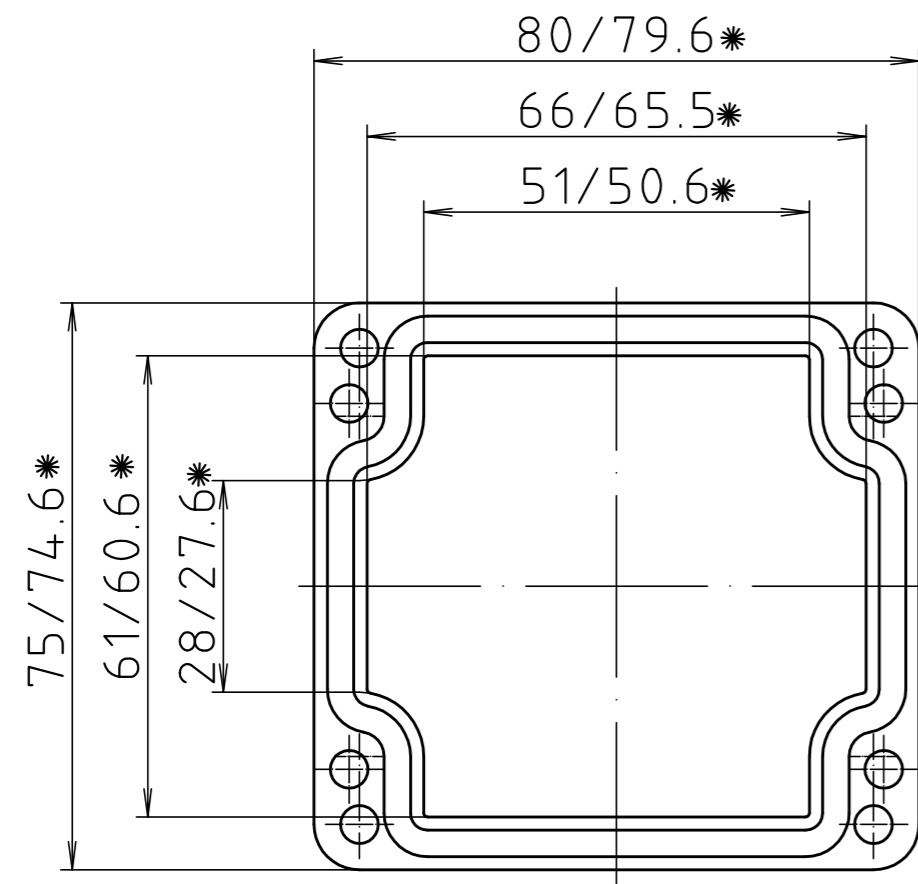

Deckel/
lid

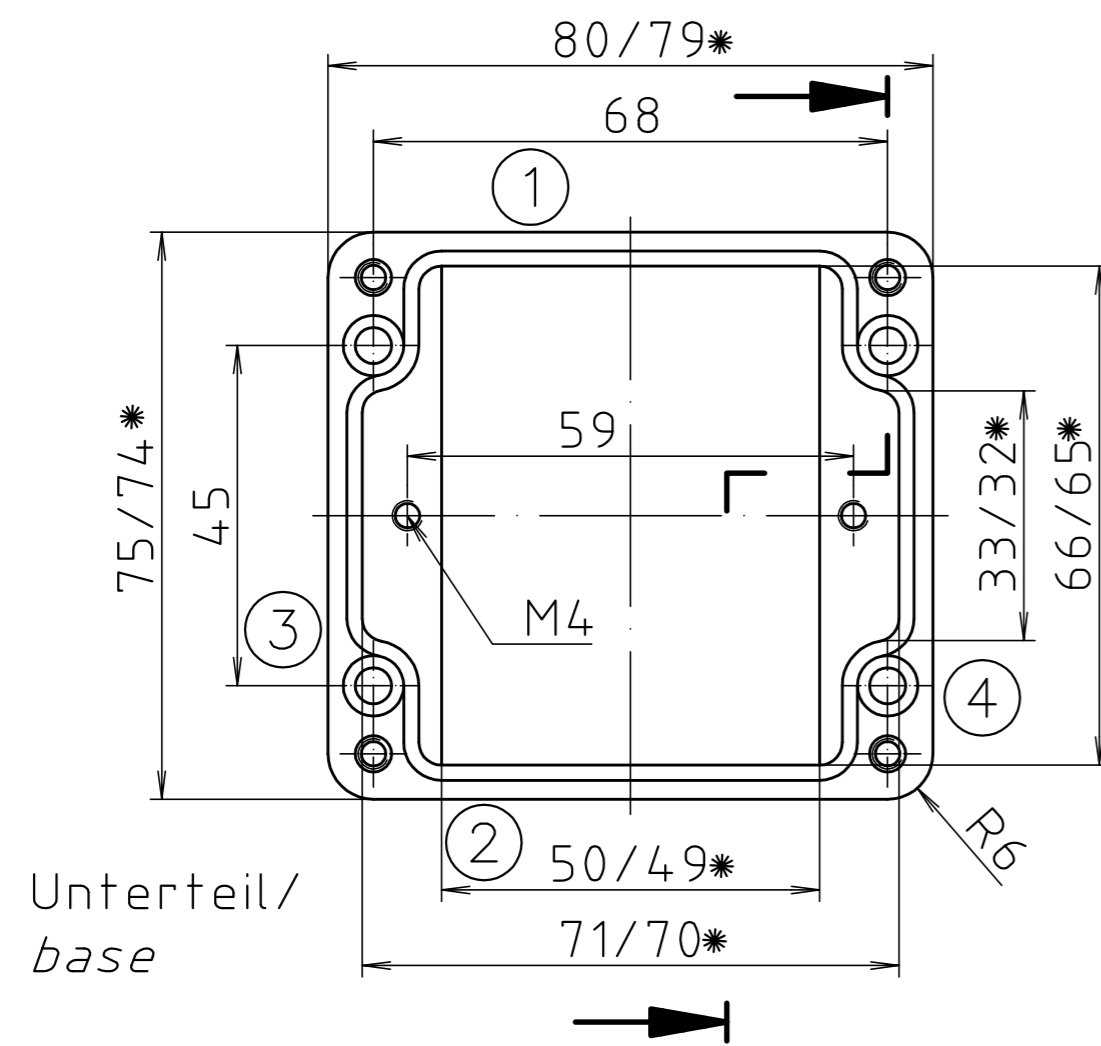

Unterteil/
base

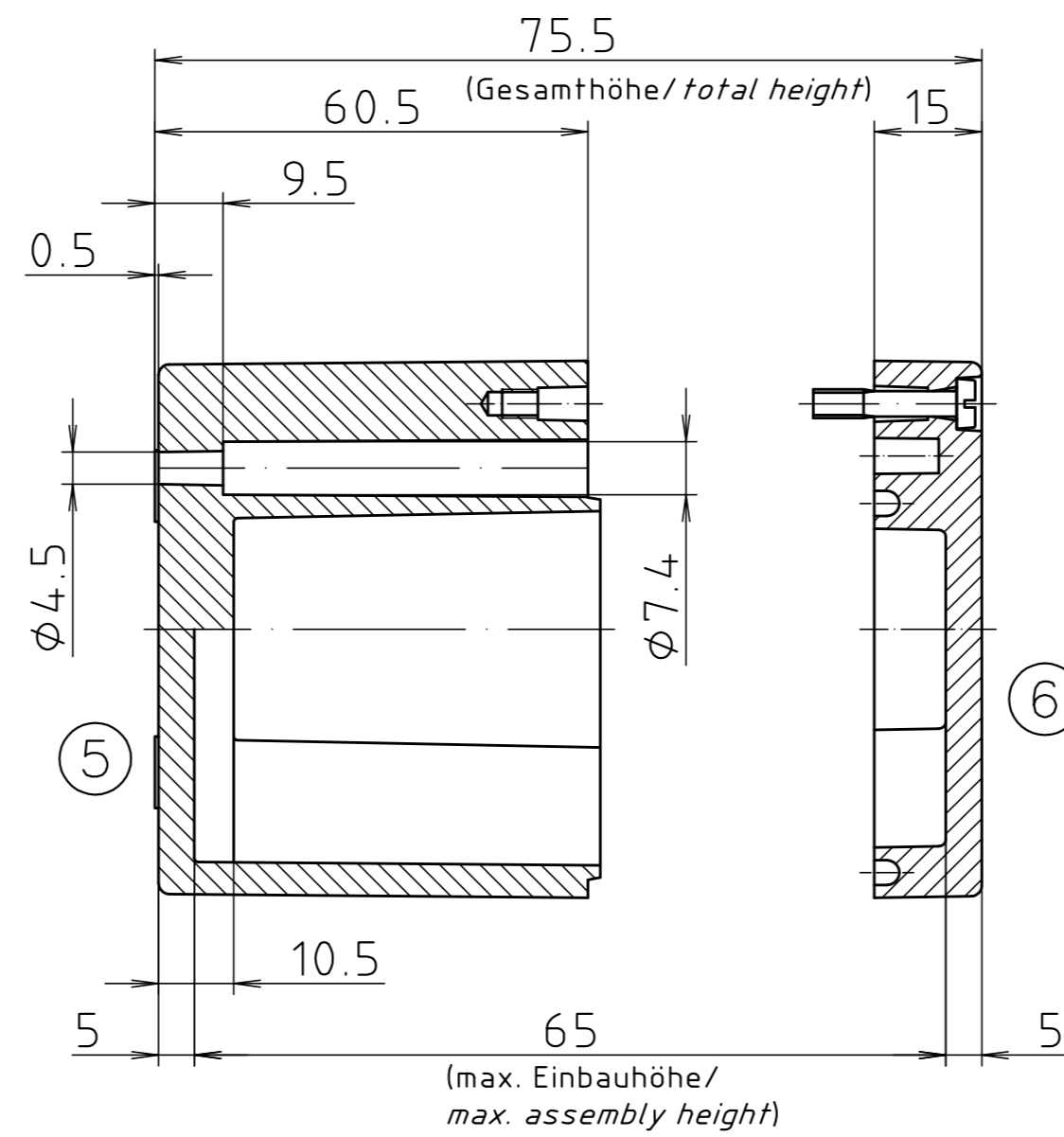

"Schutzvermerk nach DIN ISO 16016 beachten." "Please pay attention to copyright note DIN ISO 16016"

Maßstab/
Scale: 1:1

Zeichnungs-Nr. / Drawing-No.:
2K 0326.003.01

Artikel / Article:
P 326 / 2 0808 08
Katalogzeichnung/
Catalogue drawing

A.Nr./ Alt-No.:	Datum/ Date:
DISK:	2 401 761
Datum/Date: 29.03.2004 NK	

