

Schutzvermerk nach DIN ISO 16016 beachten. "Please pay attention to copyright note DIN ISO 16016"

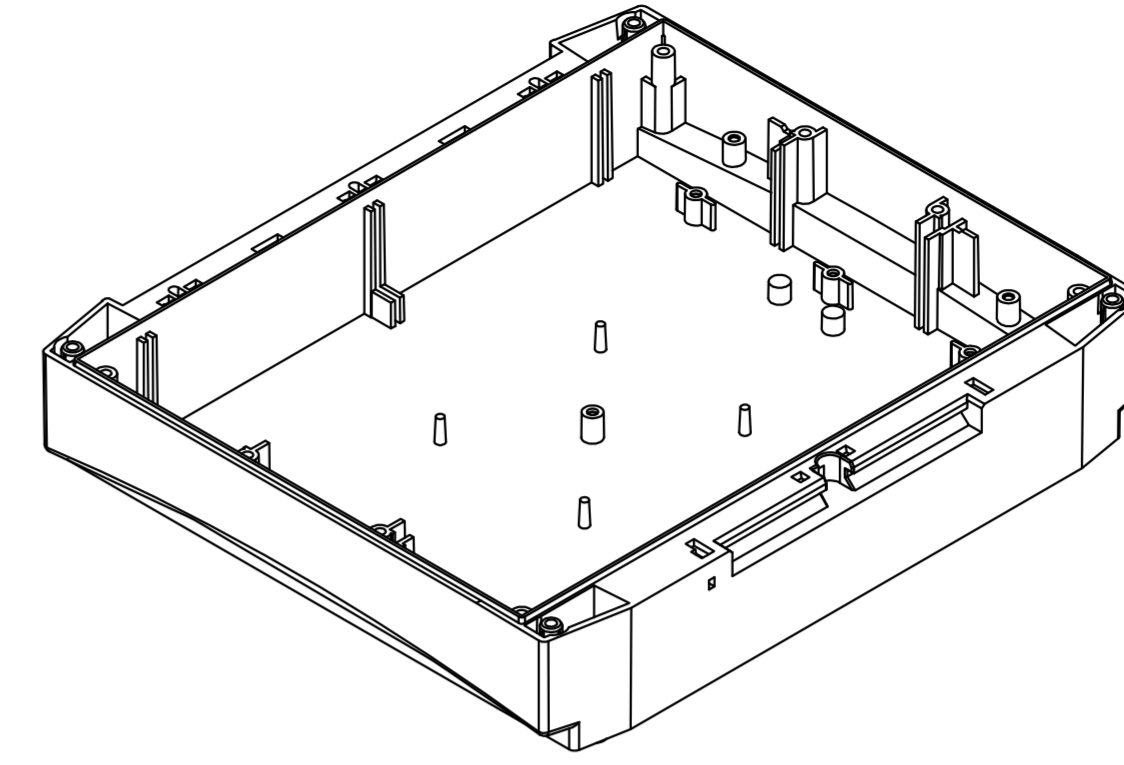

Maßstab/ Scale:	1:1	
Zeichnungs-Nr. / Drawing-No.:	1K 5335.081.01	
Artikel / Article:	BCD 200 UT-0.5	
	-	
	Katalogzeichnung/Catalogue drawing	
A-Nr./ Alt.-No.:	Datum/ Date:	
DISK:	2 602 382	
Datum/Date:	31.03.04 KH	

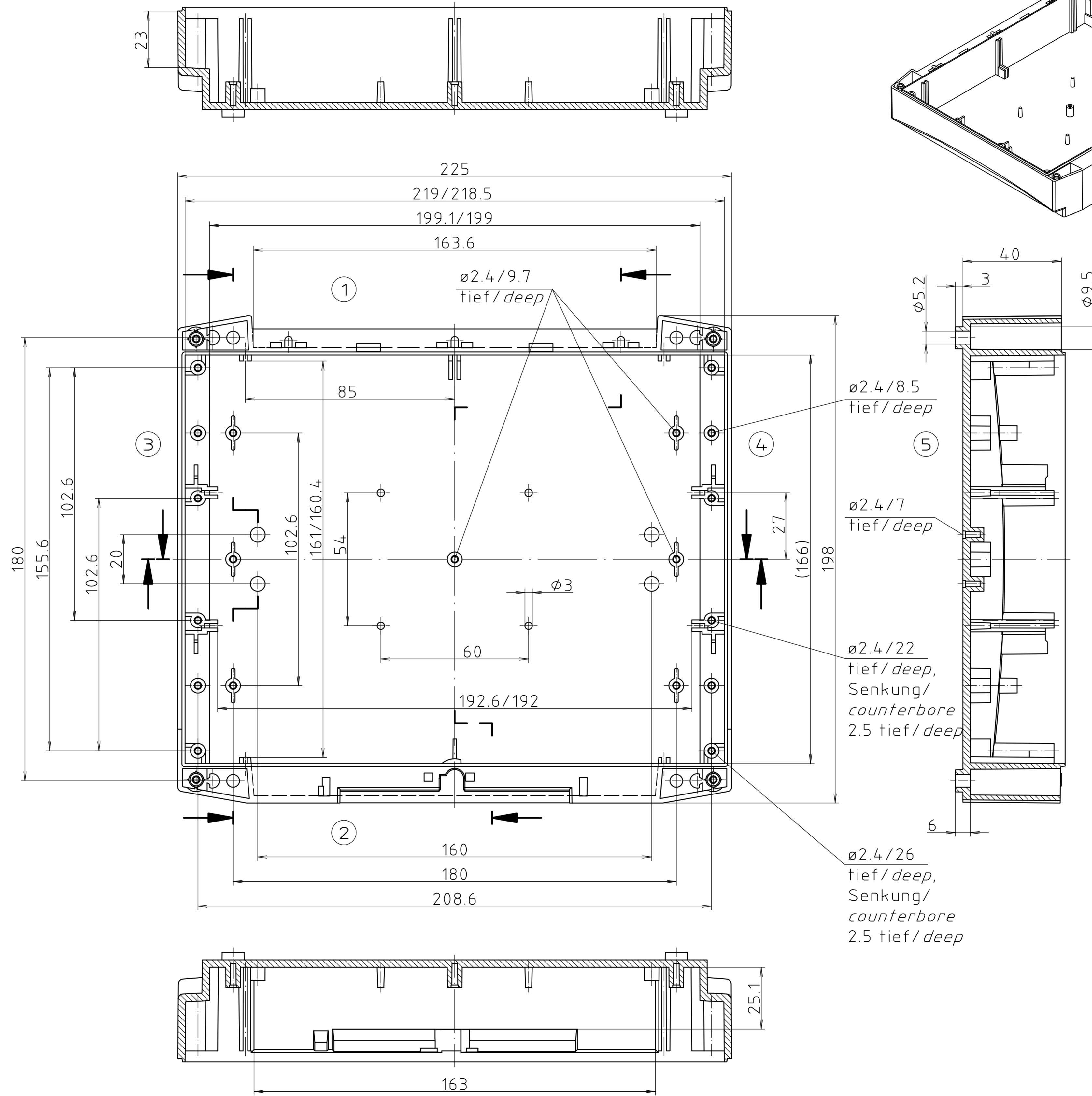
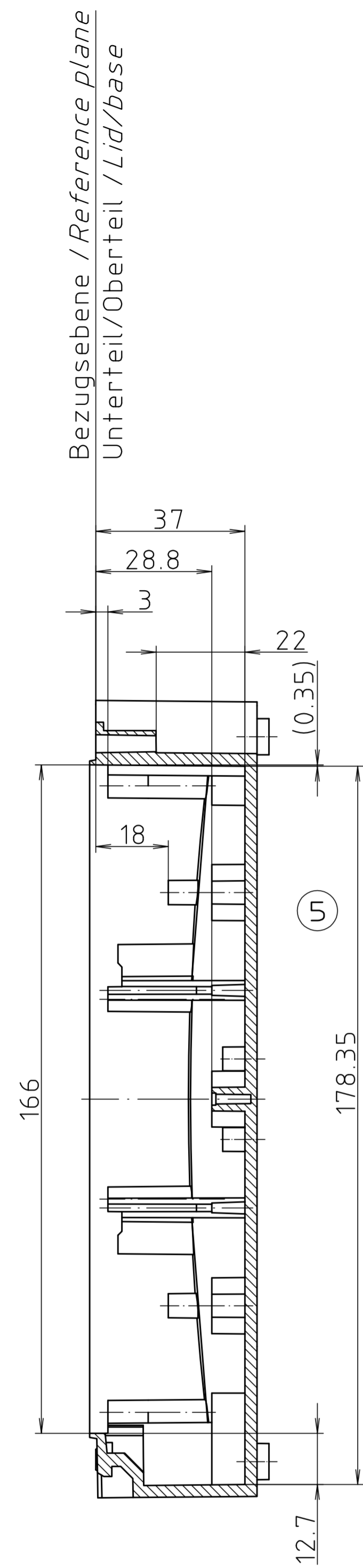