

„Schutzvermerk nach DIN ISO 16016 beachten.“ / „Please pay attention to copyright note DIN ISO 16016.“

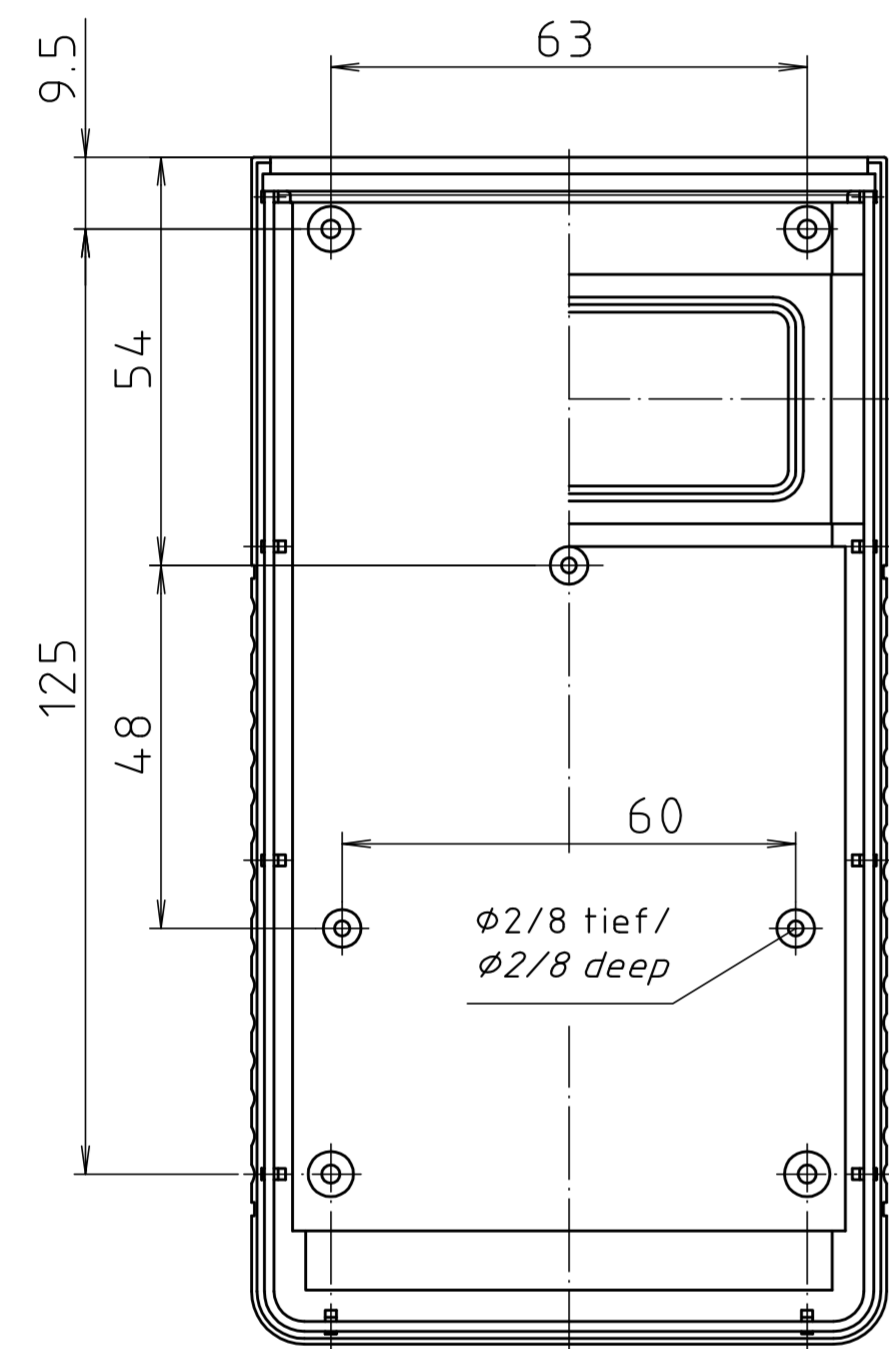

Oberteil von Innen/
top inside

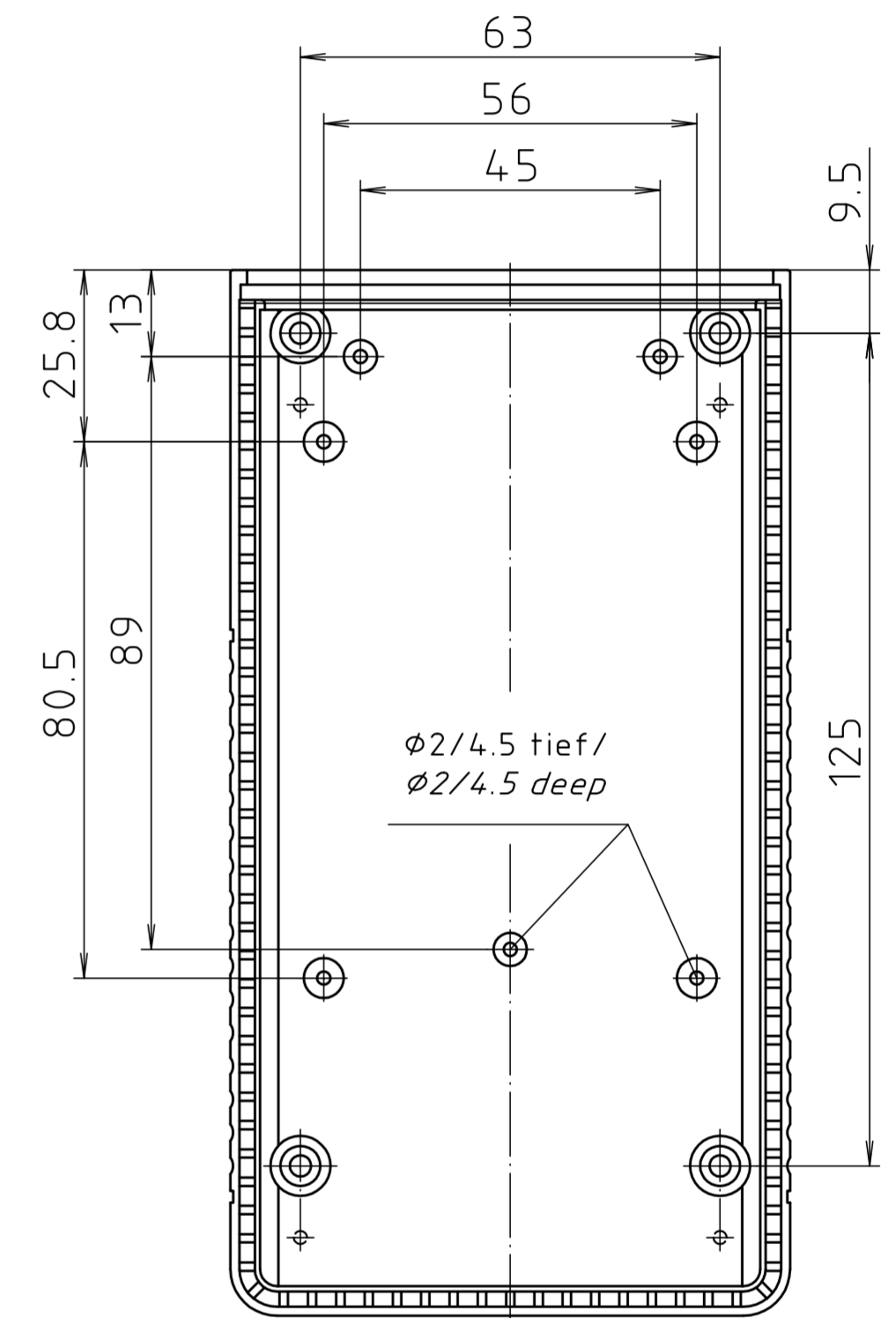
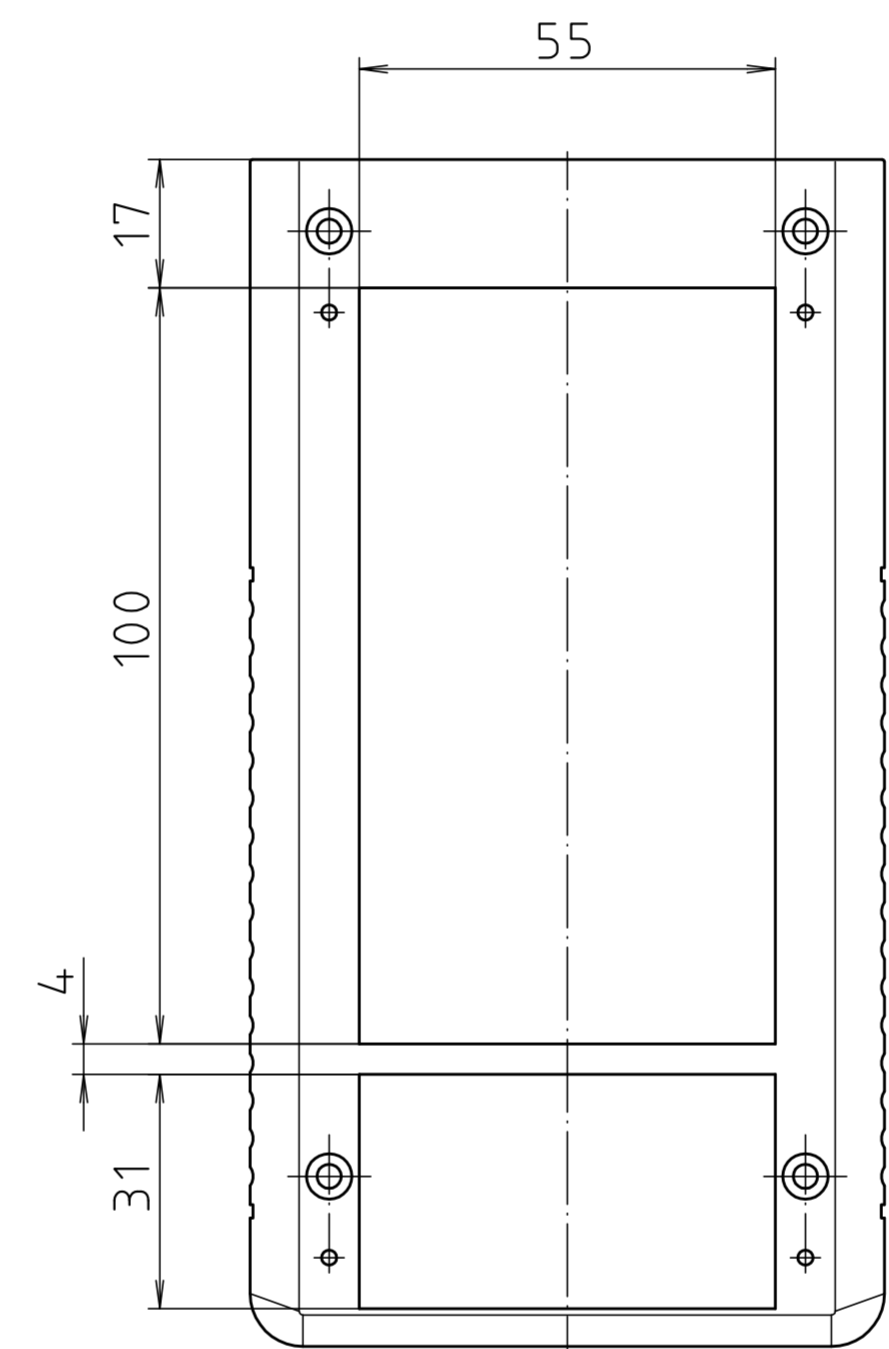
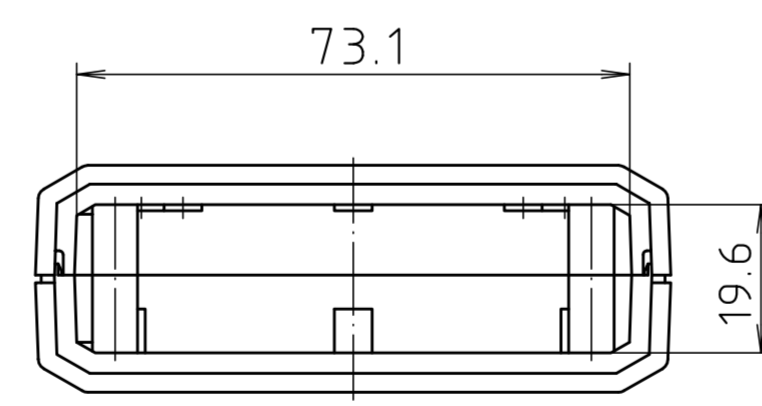
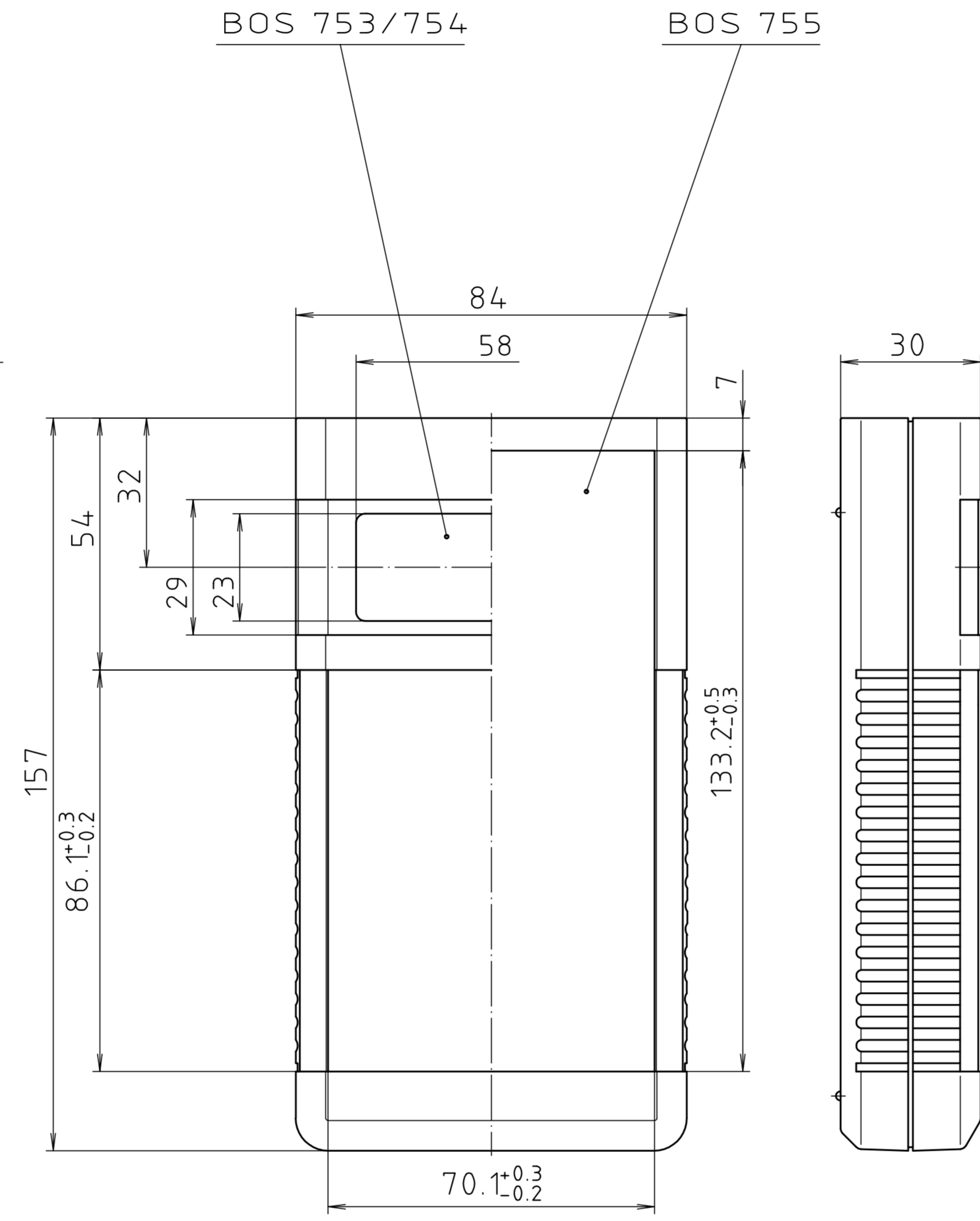
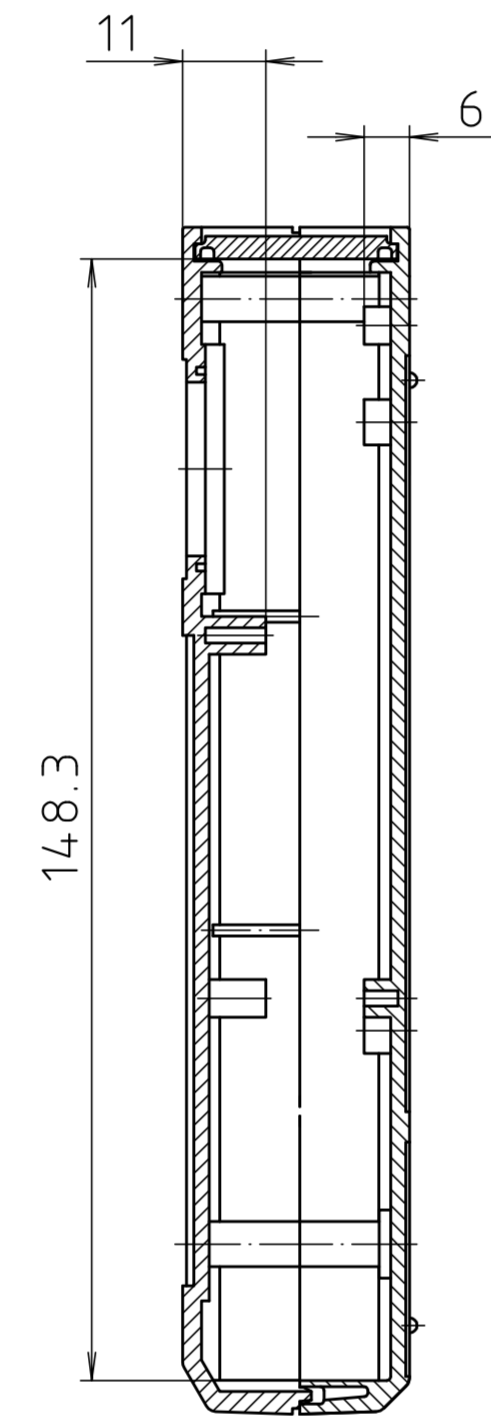

Unterteil von Innen/
base inside

Maßstab/ Scale:	1:1
Zeichnungs-Nr. / Drawing-No.:	1G 5015.136.02
Artikel / Article:	BOS 753 - 755
Katalogzeichnung/ Catalogue drawing	
A-Nr. / Art.-No.:	21.08.02
Datum / Date:	21.08.02
DISK:	2 800 814
Datum / Date:	-



BOPLA
A Phoenix Mecano Company