

"Schutzvermerk nach DIN ISO 16016 beachten." "Please pay attention to copyright note DIN ISO 16016"

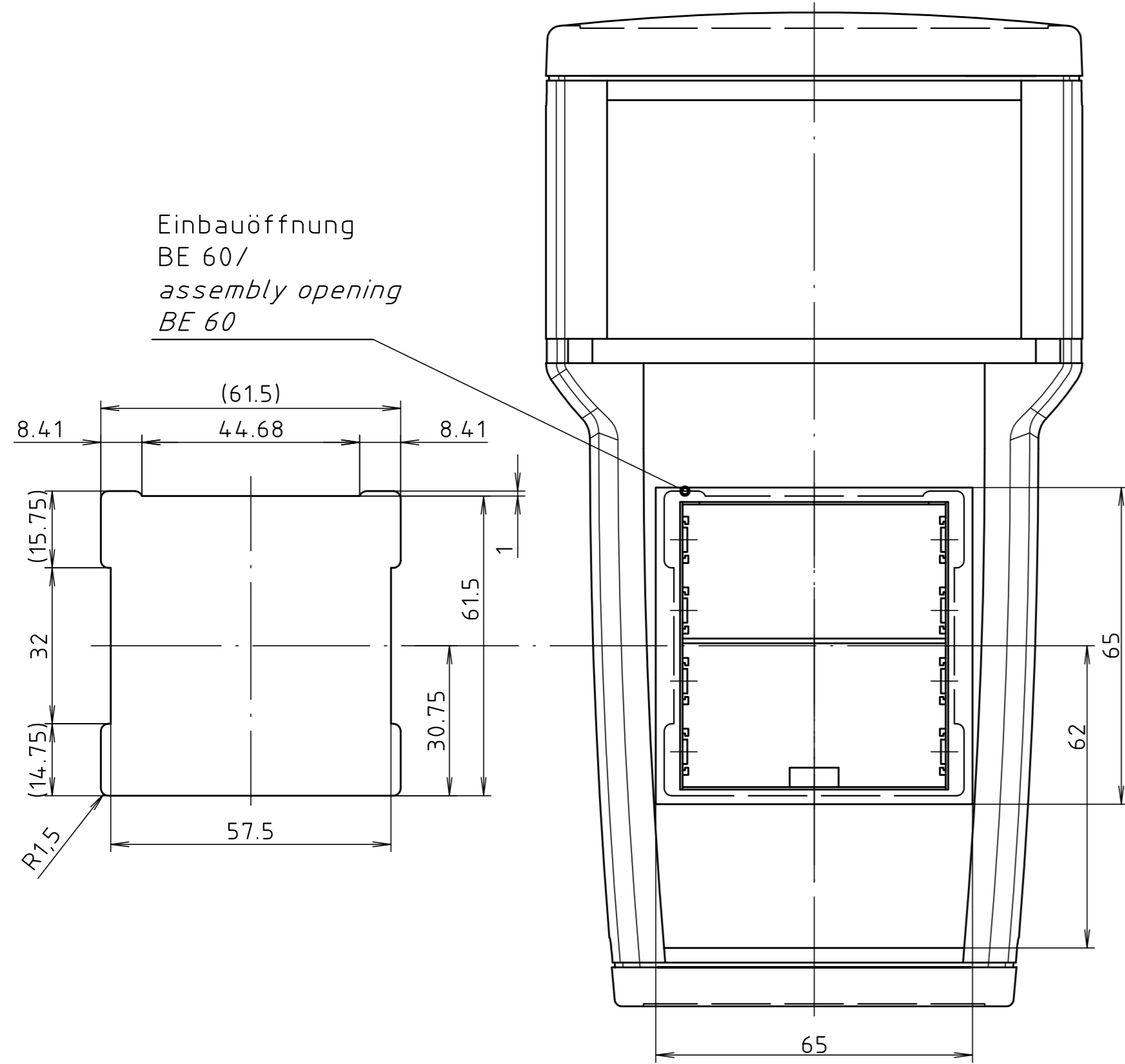

ohne Batteriefachdeckel dargestellt/
view without compartment lid

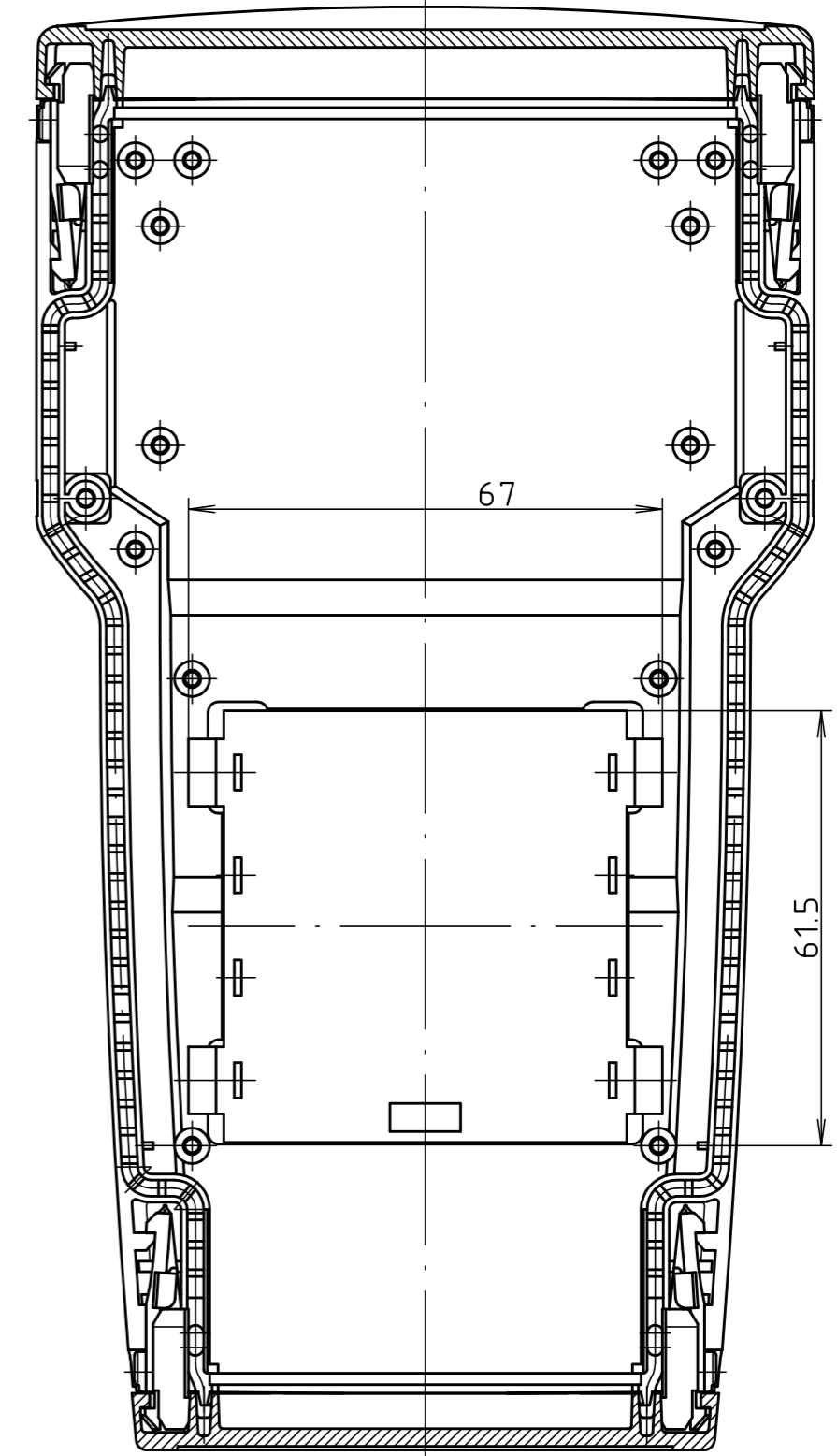
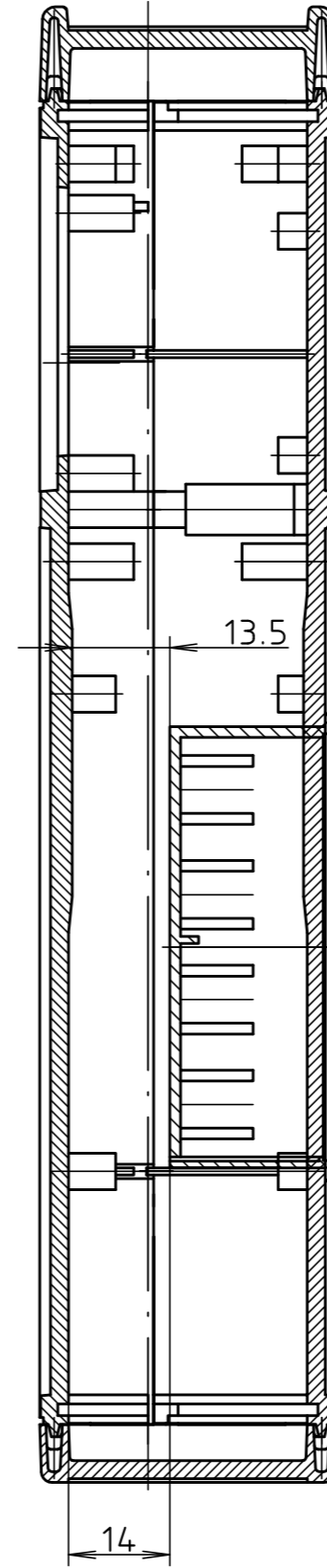

Maßstab/
Scale: 1:1



Zeichnungs-Nr. / Drawing-No.:
2K 5300.265.01

Artikel / Article:
ART 655 ___-BE60
Katalogzeichnung/
Catalogue drawing

A.Nr./
Alt-No.:
Datum/
Date:
DISK: 2 802 077
Datum/Date: 30.08.00 AK

