

Avantages produit



Euromas II n'est pas simplement une solution alternative élégante au boîtier industriel classique EUROMAS. L'accent a été particulièrement mis sur les nombreuses possibilités de montage pour les cartes C.I. et les claviers.



Les versions F présentent une surface en retrait dans la partie supérieure pour le montage en affleurement de claviers membranes.



Les bossages de fixation pour les cartes C.I. sont disposés non seulement dans la partie inférieure mais aussi dans le couvercle.



En fonction du modèle, les parties inférieures sont équipées de fixations supplémentaires spécialement conçues pour les rails DIN ou pour les bornes.



Les versions LP sont disponibles pour le montage vertical de cartes C.I.



Quick-Finder:
www.bopla.de/62

Exemples d'utilisation





BOPLA

A Phoenix Mecano Company

Euromas II



Coloris :

● Gris clair, analogue à RAL 7035

Coloris spéciaux sur demande

Type de protectio :

IP65 / DIN EN 60529

Matériau :

Boîtier : ABS ou PC (stabilisé aux UV),

Joint: CR

Détails voir « Informations techniques ».



Tailles des boîtiers

EM / ET 205



EM / ET 206



EM / ET 208

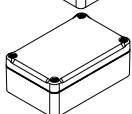

EM / ET 210

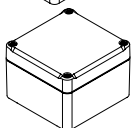

EM / ET 212

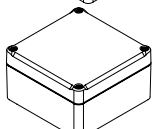

EM / ET 213

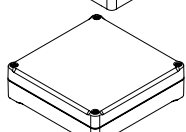

EM / ET 215

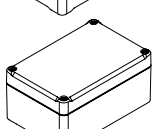

EM / ET 217

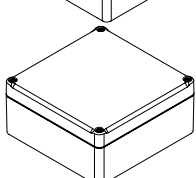

EM / ET 220

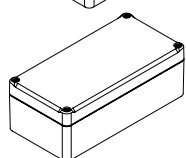

EM / ET 221

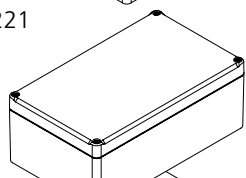

EM / ET 223

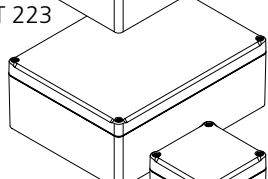

EM / ET 225

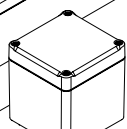

EM / ET 227

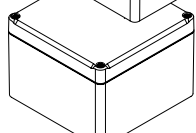

EM / ET 229

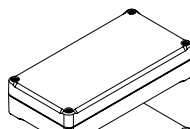

EM / ET 231

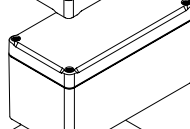

EM / ET 232

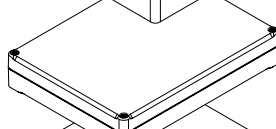

EM / ET 233

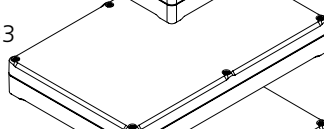

EM / ET 237

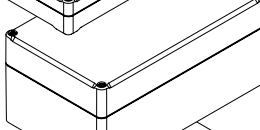

EM / ET 238

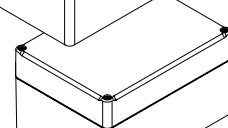

EM / ET 239

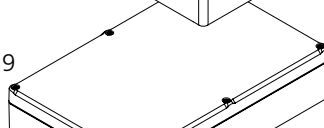

EM / ET 240

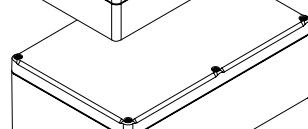

EM / ET 241

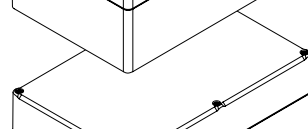

EM / ET 242

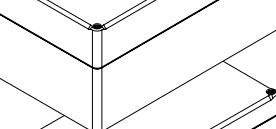

EM / ET 247

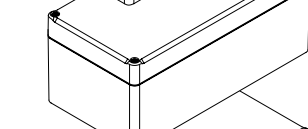

Variante de modèles

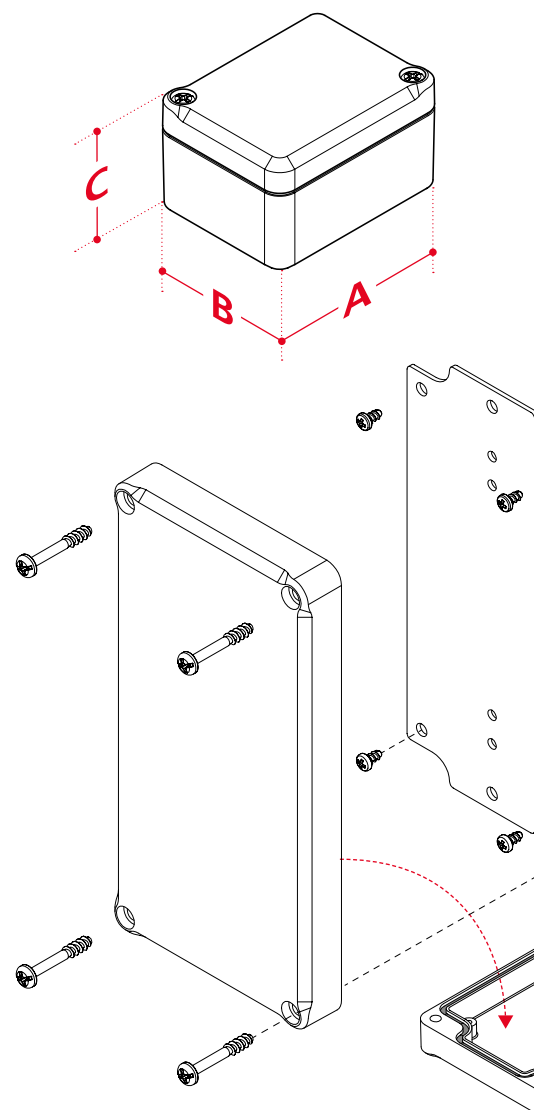

Rangée de dômes intégrée
pour le montage direct
d'un rail DIN

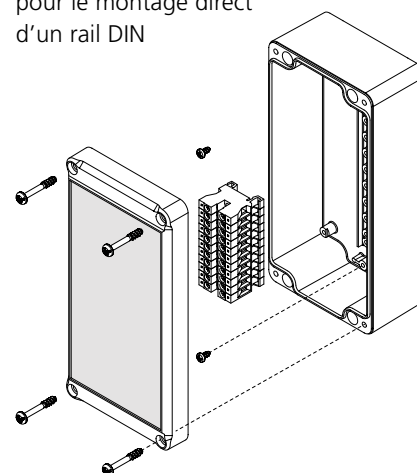

**BOPLA**

A Phoenix Mecano Company

Euromas II

EM-WL

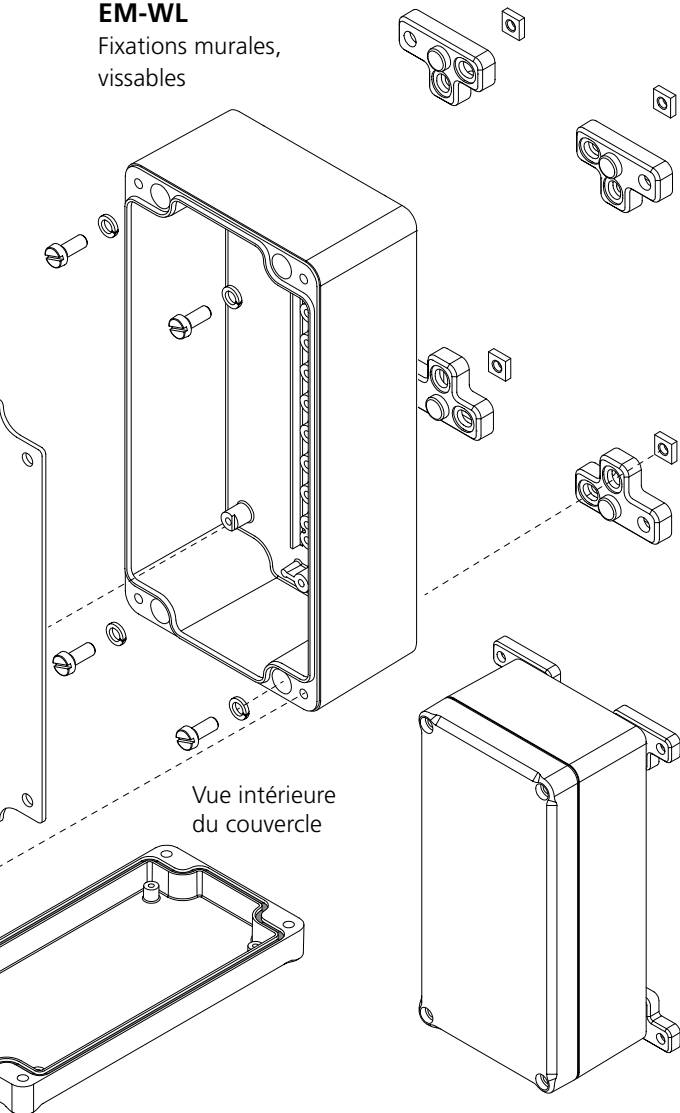
Fixations murales,
vissablesVue intérieure
du couvercle

Variante EM / ET...LP

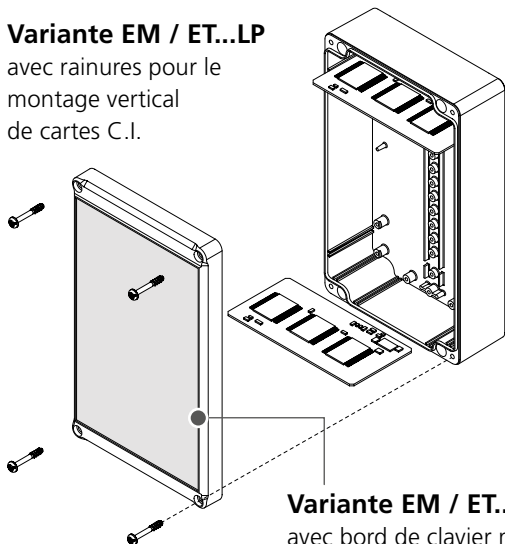
avec rainures pour le
montage vertical
de cartes C.I.

Variante EM / ET...F

avec bord de clavier membrane

Dimensions

Modèle	A	B	C	F	LP	F+LP
EM / ET 205	74	50	37	✓		
EM / ET 206	65	50	37	✓		
EM / ET 207	82	60	57		✓	✓
EM / ET 208	98	64	38	✓		
EM / ET 210	82	80	57	✓		
EM / ET 212	100	100	57	✓		
EM / ET 213	122	120	37	✓		
EM / ET 214	200	120	57		✓	✓
EM / ET 215	120	80	57	✓		
EM / ET 217	122	120	57	✓		
EM / ET 218	150	150	57		✓	✓
EM / ET 220	160	80	57	✓		
EM / ET 221	200	120	77	✓		
EM / ET 223	200	150	77	✓		
EM / ET 224	240	80	60		✓	✓
EM / ET 225	82	80	87	✓		
EM / ET 227	122	120	87	✓		
EM / ET 229	160	80	37	✓		
EM / ET 231	160	80	87	✓		
EM / ET 232	200	150	37	✓		
EM / ET 233	250	160	37	✓		
EM / ET 236	240	80	80		✓	✓
EM / ET 237	200	120	92	✓		
EM / ET 238	160	120	92	✓		
EM / ET 239	250	160	57	✓		
EM / ET 240	250	160	92	✓		
EM / ET 241	250	160	122	✓		
EM / ET 242	240	120	102	✓		
EM / ET 247	300	160	120		✓	✓

Versions EM-F / ET-F : En raison du bord du clavier membrane,
la dimension C est plus haute de 1 mm au niveau du couvercle.

Accessoires



Pieds en caoutchouc



Cache-vis

Rails DIN
TH 15, G 32, TH 35

Fixation de mât

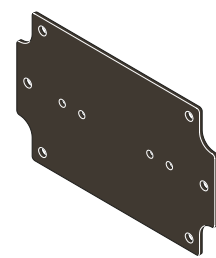
Plaques de montage en diverses
versions

Euromas II

ABS, unicolore



Boîtier, ABS

Modèle	N°. de cde	A	B	C	a1	a2	b1	b2	b3	c1	c2
ET 205	63205000	52	50	37	46.5	30	44.5	28	-	10	33
ET 206	63206000	65	50	37	59.5	43	44.5	28	-	10	32
ET 207 LP	63207300	82	60	57	75.3	56.5	53.3	25.5	-	15	51
ET 208	63208000	98	64	38	89.5	73.5	55.5	32.2	-	10	31.5
ET 210	63210000	82	80	57	75.3	56.5	73.3	36.5	-	15	51
ET 212	63212000	100	100	57	93.3	74.5	93.3	56.5	-	15	51
ET 213	63213000	122	120	37	115.6	96.8	113.6	76.8	-	15	31
ET 214 LP	63214300	200	120	57	193.2	174.4	113.2	74.3	-	15	51
ET 215	63215000	120	80	57	113.3	94.5	73.3	36.5	-	15	51
ET 217	63217000	122	120	57	115.3	96.5	113.3	76.5	-	15	51
ET 218 LP	63218300	150	150	57	143.3	124.5	143.3	106.5	-	15	51
ET 220	63220000	160	80	57	153.3	134.5	73.3	36.5	-	15	51
ET 221	63221000	200	120	77	192.9	174.1	112.9	74	-	15	71
ET 223	63223000	200	150	77	192.9	174.1	142.9	105.1	-	15	71
ET 224 LP	63224300	240	80	60	233.3	214.5	73.3	36.5	-	20	54
ET 225	63225000	82	80	87	75	56.2	73	36.2	-	15	81
ET 227	63227000	122	120	87	115	96.2	113	76.2	-	15	81
ET 229	63229000	160	80	37	153.6	134.8	73.6	36.8	-	15	31
ET 231	63231000	160	80	87	153	134.2	73	36.2	-	15	81
ET 232	63232000	200	150	37	193.6	174.8	143.6	105.8	-	15	31
ET 233	63233000	250	160	37	243.6	224.8	153.6	115.8	134.4	15	31
ET 236 LP	63236300	240	80	80	233.3	214.5	73.3	36.5	-	40	74
ET 237	63237000	200	120	92	192.9	174.1	112.9	74	-	30	86
ET 238	63238000	160	120	92	152.9	134.1	112.9	74	-	30	86
ET 239	63239000	250	160	57	243.4	224.6	153.4	115.6	134.5	15	51
ET 240	63240000	250	160	92	242.9	224.1	152.9	115.1	134.1	15	86
ET 241	63241000	250	160	122	242.9	224.1	152.9	115.1	134.1	45	116
ET 242	63242000	240	120	102	232.9	214.1	112.9	76.1	-	25	96
ET 247 LP	63247300	300	160	120	292.7	272.9	152.7	112.9	134.4	30	114

Fourniture: Parties supérieure et inférieure, vis autotaraudeuses en V2A pour le couvercle

Remarque: En raison d'un retrait différent du matériau, les boîtiers en ABS peuvent être env. 0,1 – 0,25 % plus grands.



BOPLA

A Phoenix Mecano Company

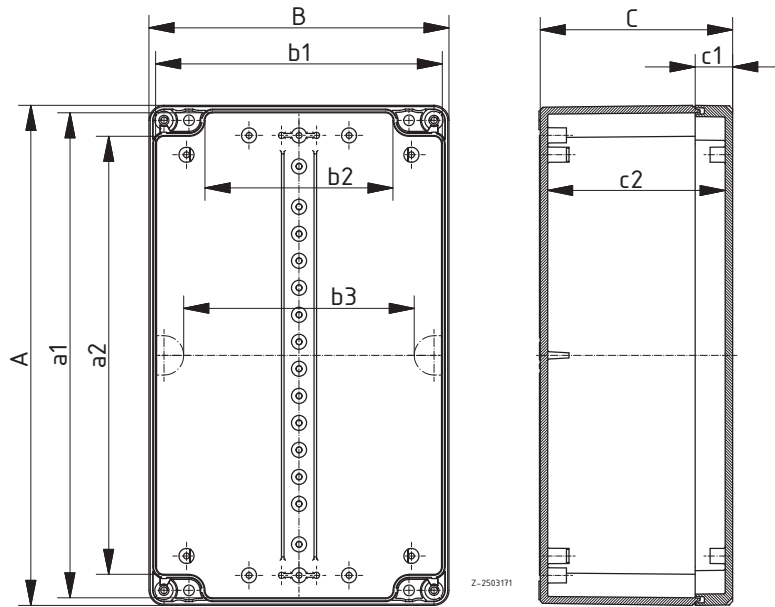

Euromas II

ABS, avec bordure de clavier membrane



Boîtier, ABS

Modèle	N°. de cde	A	B	C	a1	a2	b1	b2	b3	c1	c2
ET 205 F	63205200	52	50	37	46.5	30	44.5	28	-	10	33
ET 206 F	63206200	65	50	37	59.5	43	44.5	28	-	10	32
ET 207 F-LP	63207400	82	60	57	75.3	56.5	53.3	25.5	-	15	51
ET 208 F	63208200	98	64	38	89.5	73.5	55.5	32.2	-	10	31.5
ET 210 F	63210200	82	80	57	75.3	56.5	73.3	36.5	-	15	51
ET 212 F	63212200	100	100	57	93.3	74.5	93.3	56.5	-	15	51
ET 213 F	63213200	122	120	37	115.6	96.8	113.6	76.8	-	15	31
ET 214 F-LP	63214400	200	120	57	193.2	174.4	113.2	74.3	-	15	51
ET 215 F	63215200	120	80	57	113.3	94.5	73.3	36.5	-	15	51
ET 217 F	63217200	122	120	57	115.3	96.5	113.3	76.5	-	15	51
ET 218 F-LP	63218400	150	150	57	143.3	124.5	143.3	106.5	-	15	51
ET 220 F	63220200	160	80	57	153.3	134.5	73.3	36.5	-	15	51
ET 221 F	63221200	200	120	77	192.9	174.1	112.9	74	-	15	71
ET 223 F	63223200	200	150	77	192.9	174.1	142.9	105.1	-	15	71
ET 224 F-LP	63224400	240	80	60	233.3	214.5	73.3	36.5	-	20	54
ET 225 F	63225200	82	80	87	75	56.2	73	36.2	-	15	81
ET 227 F	63227200	122	120	87	115	96.2	113	76.2	-	15	81
ET 229 F	63229200	160	80	37	153.6	134.8	73.6	36.8	-	15	31
ET 231 F	63231200	160	80	87	153	134.2	73	36.2	-	15	81
ET 232 F	63232200	200	150	37	193.6	174.8	143.6	105.8	-	15	31
ET 233 F	63233200	250	160	37	243.6	224.8	153.6	115.8	134.4	15	31
ET 236 F-LP	63236400	240	80	80	233.3	214.5	73.3	36.5	-	40	74
ET 237 F	63237200	200	120	92	192.9	174.1	112.9	74	-	30	86
ET 238 F	63238200	160	120	92	152.9	134.1	112.9	74	-	30	86
ET 239 F	63239200	250	160	57	243.4	224.6	153.4	115.6	134.5	15	51
ET 240 F	63240200	250	160	92	242.9	224.1	152.9	115.1	134.1	15	86
ET 241 F	63241200	250	160	122	242.9	224.1	152.9	115.1	134.1	45	116
ET 242 F	63242200	240	120	102	232.9	214.1	112.9	76.1	-	25	96
ET 247 F-LP	63247400	300	160	120	292.7	272.9	152.7	112.9	134.4	30	114

Fourniture: Parties supérieure et inférieure, vis autotaraudeuses en V2A pour le couvercle

Remarque: En raison d'un retrait différent du matériau, les boîtiers en ABS peuvent être env. 0,1 – 0,25 % plus grands.



BOPLA

A Phoenix Mecano Company

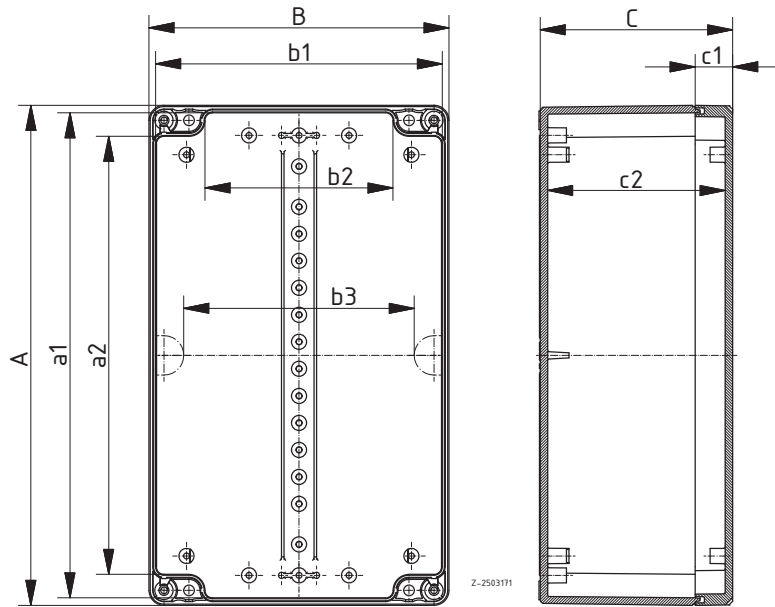

Euromas II

PC, unicolore



Boîtier, polycarbonate

Modèle	N°. de cde	A	B	C	a1	a2	b1	b2	b3	c1	c2
EM 205	62205000	52	50	37	46.5	30	44.5	28	-	10	33
EM 206	62206000	65	50	37	59.5	43	44.5	28	-	10	32
EM 207 LP	62207300	82	60	57	75.3	56.5	53.3	25.5	-	15	51
EM 208	62208000	98	64	38	89.5	73.5	55.5	32.2	-	10	31.5
EM 210	62210000	82	80	57	75.3	56.5	73.3	36.5	-	15	51
EM 212	62212000	100	100	57	93.3	74.5	93.3	56.5	-	15	51
EM 213	62213000*	122	120	37	115.6	96.8	113.6	76.8	-	15	31
EM 214 LP	62214300	200	120	57	193.2	174.4	113.2	74.3	-	15	51
EM 215	62215000	120	80	57	113.3	94.5	73.3	36.5	-	15	51
EM 217	62217000	122	120	57	115.3	96.5	113.3	76.5	-	15	51
EM 218 LP	62218300	150	150	57	143.3	124.5	143.3	106.5	-	15	51
EM 220	62220000	160	80	57	153.3	134.5	73.3	36.5	-	15	51
EM 221	62221000	200	120	77	192.9	174.1	112.9	74	-	15	71
EM 223	62223000	200	150	77	192.9	174.1	142.9	105.1	-	15	71
EM 224 LP	62224300	240	80	60	233.3	214.5	73.3	36.5	-	20	54
EM 225	62225000	82	80	87	75	56.2	73	36.2	-	15	81
EM 227	62227000	122	120	87	115	96.2	113	76.2	-	15	81
EM 229	62229000*	160	80	37	153.6	134.8	73.6	36.8	-	15	31
EM 231	62231000	160	80	87	153	134.2	73	36.2	-	15	81
EM 232	62232000*	200	150	37	193.6	174.8	143.6	105.8	-	15	31
EM 233	62233000*	250	160	37	243.6	224.8	153.6	115.8	134.4	15	31
EM 236 LP	62236300	240	80	80	233.3	214.5	73.3	36.5	-	40	74
EM 237	62237000	200	120	92	192.9	174.1	112.9	74	-	30	86
EM 238	62238000	160	120	92	152.9	134.1	112.9	74	-	30	86
EM 239	62239000	250	160	57	243.4	224.6	153.4	115.6	134.5	15	51
EM 240	62240000	250	160	92	242.9	224.1	152.9	115.1	134.1	15	86
EM 241	62241000	250	160	122	242.9	224.1	152.9	115.1	134.1	45	116
EM 242	62242000	240	120	102	232.9	214.1	112.9	76.1	-	25	96
EM 247 LP	62247300	300	160	120	292.7	272.9	152.7	112.9	134.4	30	114

Fourniture: Parties supérieure et inférieure, vis autotaraudeuses en V2A pour le couvercle

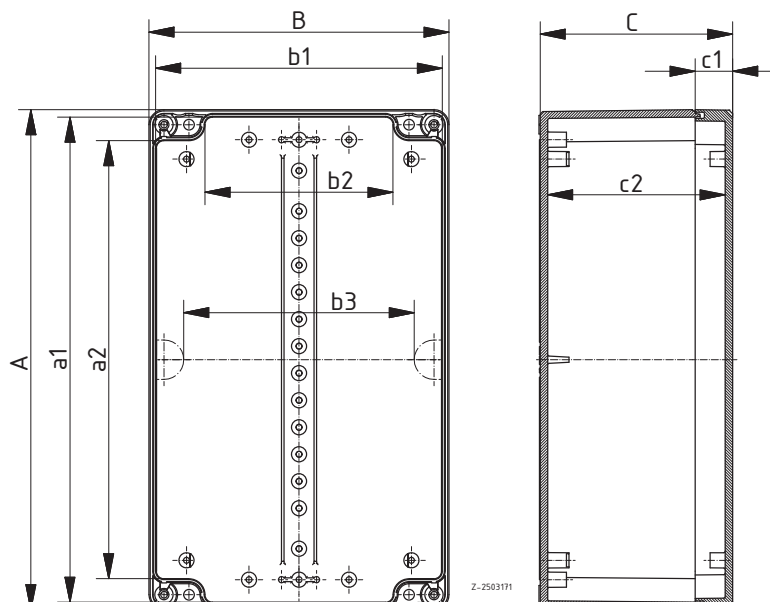

Euromas II

PC, avec bord de clavier membrane

Boîtier, polycarbonate

Modèle	N°. de cde	A	B	C	a1	a2	b1	b2	b3	c1	c2
EM 205 F	62205200	52	50	37	46.5	30	44.5	28	-	10	33
EM 206 F	62206200	65	50	37	59.5	43	44.5	28	-	10	32
EM 207 F-LP	62207400	82	60	57	75.3	56.5	53.3	25.5	-	15	51
EM 208 F	62208200	98	64	38	89.5	73.5	55.5	32.2	-	10	31.5
EM 210 F	62210200	82	80	57	75.3	56.5	73.3	36.5	-	15	51
EM 212 F	62212200	100	100	57	93.3	74.5	93.3	56.5	-	15	51
EM 213 F	62213200*	122	120	37	115.6	96.8	113.6	76.8	-	15	31
EM 214 F-LP	62214400	200	120	57	193.2	174.4	113.2	74.3	-	15	51
EM 215 F	62215200	120	80	57	113.3	94.5	73.3	36.5	-	15	51
EM 217 F	62217200	122	120	57	115.3	96.5	113.3	76.5	-	15	51
EM 218 F-LP	62218400	150	150	57	143.3	124.5	143.3	106.5	-	15	51
EM 220 F	62220200	160	80	57	153.3	134.5	73.3	36.5	-	15	51
EM 221 F	62221200	200	120	77	192.9	174.1	112.9	74	-	15	71
EM 223 F	62223200	200	150	77	192.9	174.1	142.9	105.1	-	15	71
EM 224 F-LP	62224400	240	80	60	233.3	214.5	73.3	36.5	-	20	54
EM 225 F	62225200	82	80	87	75	56.2	73	36.2	-	15	81
EM 227 F	62227200	122	120	87	115	96.2	113	76.2	-	15	81
EM 229 F	62229200*	160	80	37	153.6	134.8	73.6	36.8	-	15	31
EM 231 F	62231200	160	80	87	153	134.2	73	36.2	-	15	81
EM 232 F	62232200*	200	150	37	193.6	174.8	143.6	105.8	-	15	31
EM 233 F	62233200*	250	160	37	243.6	224.8	153.6	115.8	134.4	15	31
EM 236 F-LP	62236400	240	80	80	233.3	214.5	73.3	36.5	-	40	74
EM 237 F	62237200	200	120	92	192.9	174.1	112.9	74	-	30	86
EM 238 F	62238200	160	120	92	152.9	134.1	112.9	74	-	30	86
EM 239 F	62239200	250	160	57	243.4	224.6	153.4	115.6	134.5	15	51
EM 240 F	62240200	250	160	92	242.9	224.1	152.9	115.1	134.1	15	86
EM 241 F	62241200	250	160	122	242.9	224.1	152.9	115.1	134.1	45	116
EM 242 F	62242200	240	120	102	232.9	214.1	112.9	76.1	-	25	96
EM 247 F-LP	62247400	300	160	120	292.7	272.9	152.7	112.9	134.4	30	114



Fourniture: Parties supérieure et inférieure, vis autotaraudeuses en V2A pour le couvercle

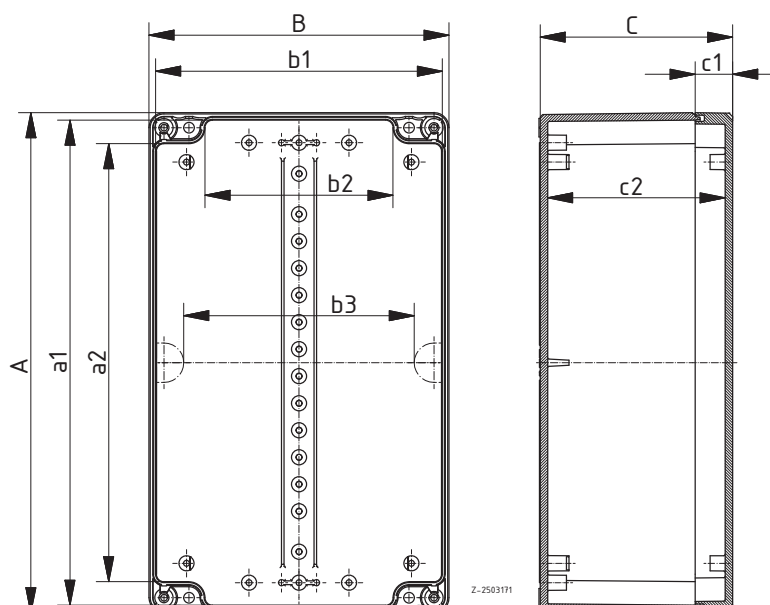

Euromas II

Plaques de montage



Plaques de montage, bakélite

Modèle	N°. de cde	Remarque
M	22000100	Pour EM/ET 205, M/T 205
M	22000200	Pour EM/ET 206, M/T 206
M	22207001	Pour EM/ET 207**
M	22000300	Pour EM/ET 210, EM/ET 225, M/T 210, M/T 225
M	22000400	Pour EM/ET 215, M/T 215-216, M/T 226, M/T 230
M	22212000	Pour EM/ET 212**
M	22000500	Pour EM/ET 217, EM/ET 227, M/T 217, M/T 227-228
M	22214001	Pour EM/ET 214**
M	22000600	Pour EM/ET 220, EM/ET 231, M/T 219-220, M/T 231-235
M	22000700	Pour EM/ET 221, EM/ET 237, M/T 221, M/T 237
M	22000800	Pour EM/ET 223, M/T 223
M	22218001	Pour EM/ET 218**
M	22000900	Pour EM/ET 239-241, M/T 240, M/T 241, M/T 250
M	22001100	Pour EM/ET 238, M/T 238, M/T 2381, M/T 246
M	22001200	Pour EM/ET 242, M/T 242
M	22224001	Pour EM/ET 224, EM/ET 236**
M	22247001	Pour EM/ET 247**

Fourniture: 1 plaque de montage

Remarque: * = La plaque de montage est également montable dans le couvercle de boîtier.

Euromas II

Accessoires

Fixation pour poteau, acier inoxydable V2A, sans revêtement

Modèle	N°. de cde
MH 080	96500080
MH 122	96500122
MH 167	96500167
MH 220	96500220
MH 265	96500265

Fourniture: MH : 1 jeu (2 pièces) BFS : 20 pièces

Remarque: Merci de commander séparément le kit de fixation et le collier de fixation pour poteau d'après le tableau. ** = Disponible à partir de juillet 2021



Verwendung der Mastbefestigung für Euromas II
Use of the mast mounting for Euromas II

Bitte wählen Sie anhand dieser Tabelle je nach Größe und Ausrichtung des Gehäuses die passende Mastbefestigung und den dazugehörigen Befestigungsatz aus.
Please use this table to select the appropriate mast mounting and the associated mounting kit, depending on the size and alignment of the enclosure.

Ausrichtung des Gehäuses / Alignment of the enclosure:
H = horizontal
V = vertical

Gehäuse Enclosure	Mastbefestigung Mast mounting	Befestigungsatz Mounting kit
EMET 210 H	MH 080	BFS MH 1
EMET 210 V	MH 080	BFS MH 1
EMET 212 H	MH 122	BFS MH 1
EMET 212 V	MH 080	BFS MH 1
EMET 213 V(H)	MH 122	BFS MH 1
EMET 214LP H	MH 220	BFS MH 1
EMET 214LP V	MH 122	BFS MH 1
EMET 215 H	MH 122	BFS MH 1
EMET 215 V	MH 080	BFS MH 1
EMET 217 V(H)	MH 122	BFS MH 1
EMET 218LP H	MH 167	BFS MH 1
EMET 218LP V	MH 167	BFS MH 1
EMET 220 H	MH 220	BFS MH 1
EMET 220 V	MH 080	BFS MH 1
EMET 221 H	MH 122	BFS MH 1
EMET 221 V	MH 220	BFS MH 1
EMET 223 V	MH 167	BFS MH 1
EMET 224 H	MH 265	BFS MH 1
EMET 224 V	MH 080	BFS MH 1
EMET 225 H	MH 080	BFS MH 1
EMET 225 V	MH 080	BFS MH 1
EMET 227 V	MH 122	BFS MH 1
EMET 229 H	MH 167	BFS MH 1
EMET 229 V	MH 080	BFS MH 1
EMET 231 H	MH 167	BFS MH 1
EMET 231 V	MH 080	BFS MH 1
EMET 232 H	MH 220	BFS MH 1
EMET 232 V	MH 167	BFS MH 1
EMET 234LP H	MH 265	BFS MH 1
EMET 234LP V	MH 080	BFS MH 1
EMET 237 H	MH 220	BFS MH 1
EMET 238 H	MH 167	BFS MH 1
EMET 238 V	MH 122	BFS MH 1
EMET 239 H	MH 265	BFS MH 1
EMET 239 V	MH 167	BFS MH 1
EMET 240 H	MH 265	BFS MH 1
EMET 240 V	MH 167	BFS MH 1
EMET 241 H	MH 265	BFS MH 1
EMET 241 V	MH 167	BFS MH 1
EMET 242 H	MH 265	BFS MH 1
EMET 242 V	MH 122	BFS MH 1
EMET 247 V	MH 167	BFS MH 1

Stand 23.03.2021



H = horizontal



V = vertical

Jeu de fixation sur poteau

Modèle	N°. de cde	Remarque
BFS MH 1	96500001	Kit de fixation
BFS MH 2	96500002	Kit de fixation
BFS MH 3	96500003	Kit de fixation

Fourniture: 20 unités (pour 5 jeux de fixations sur poteau)

Remarque: Merci de choisir la fixation sur poteau adéquate en fonction de la taille du boîtier ainsi que le jeu de fixation correspondant dans le tableau (voir « Informations produits »).



Euromas II

Accessoires



Bride de serrage pour fixation sur poteau, acier inoxydable

Modèle	N°. de cde	Remarque
MH S 32-50	96500050	Plage de serrage 32 à -50 mm
MH S 50-70	96500070	Plage de serrage 50 à -70 mm
MH S 70-90	96500090	Plage de serrage 70 à -90 mm
MH S 90-110	96500110	Plage de serrage 90 à -110 mm
MH S 110-130	96500130	Plage de serrage 110 à -130 mm
MH S 130-150	96500150	Plage de serrage 130 à -150 mm
MH S 150-170	96500175	Plage de serrage 150 à -170 mm
MH S 170-190	96500190	Plage de serrage 170 à -190 mm
MH S 190-210	96500210	Plage de serrage 190 à -210 mm

Fourniture: 10 pièces

Verwendung der Mastbefestigung für Euromas II
Use of the mast mounting for Euromas II

A Phoenix Mecano Company

Bitte wählen Sie anhand dieser Tabelle je nach Größe und Ausrichtung des Gehäuses die passende Mastbefestigung und den dazugehörigen Befestigungssatz aus.

Please use this table to select the appropriate mast mounting and the associated mounting kit, depending on the size and alignment of the enclosure.

Ausrichtung des Gehäuses / Alignment of the enclosure :

H = horizontal

V = vertical

Gehäuse Enclosure	Mastbefestigung Mast mounting		Befestigungssatz Mounting kit
EM/ET 210 H	= MH 080	+	BFS MH 1
EM/ET 210 V	= MH 080	+	BFS MH 1
EM/ET 212 H	= MH 122	+	BFS MH 1
EM/ET 212 V	= MH 080	+	BFS MH 1
EM/ET 213 V/H	= MH 122	+	BFS MH 1
EM/ET 214-LP H	= MH 220	+	BFS MH 1
EM/ET 214-LP V	= MH 122	+	BFS MH 1
EM/ET 215 H	= MH 122	+	BFS MH 1
EM/ET 215 V	= MH 080	+	BFS MH 1
EM/ET 217 V/H	= MH 122	+	BFS MH 1
EM/ET 218-LP H	= MH 167	+	BFS MH 1
EM/ET 218-LP V	= MH 167	+	BFS MH 1
EM/ET 220 H	= MH 167	+	BFS MH 1
EM/ET 220 V	= MH 080	+	BFS MH 1
EM/ET 221 H	= MH 220	+	BFS MH 1
EM/ET 221 V	= MH 122	+	BFS MH 1
EM/ET 223 H	= MH 220	+	BFS MH 1
EM/ET 223 V	= MH 167	+	BFS MH 1
EM/ET 224 H	= MH 265	+	BFS MH 1
EM/ET 224 V	= MH 080	+	BFS MH 1
EM/ET 225 H	= MH 080	+	BFS MH 1
EM/ET 225 V	= MH 080	+	BFS MH 1
EM/ET 227 V	= MH 122	+	BFS MH 1
EM/ET 229 H	= MH 167	+	BFS MH 1
EM/ET 229 V	= MH 080	+	BFS MH 1
EM/ET 231 H	= MH 167	+	BFS MH 1
EM/ET 231 V	= MH 080	+	BFS MH 1
EM/ET 232 H	= MH 220	+	BFS MH 1
EM/ET 232 V	= MH 167	+	BFS MH 1
EM/ET 233 V	= MH 167	+	BFS MH 1
EM/ET 236-LP H	= MH 265	+	BFS MH 1
EM/ET 236-LP V	= MH 080	+	BFS MH 1
EM/ET 237 H	= MH 220	+	BFS MH 1
EM/ET 237 V	= MH 122	+	BFS MH 1
EM/ET 238 H	= MH 167	+	BFS MH 1
EM/ET 238 V	= MH 122	+	BFS MH 1
EM/ET 239 H	= MH 265	+	BFS MH 1
EM/ET 239 V	= MH 167	+	BFS MH 1
EM/ET 240 H	= MH 265	+	BFS MH 1
EM/ET 240 V	= MH 167	+	BFS MH 1
EM/ET 241 H	= MH 265	+	BFS MH 1
EM/ET 241 V	= MH 167	+	BFS MH 1
EM/ET 242 H	= MH 265	+	BFS MH 1
EM/ET 242 V	= MH 122	+	BFS MH 1
EM/ET 247 V	= MH 167	+	BFS MH 1

H = horizontal



V = vertical



Stand 23.03.2021

Euromas II

Accessoires



Fixations murales vissables sur l'arrière

Modèle	N°. de cde
EM-WL	22010000

Fourniture: 4 fixations murales (polycarbonate), vis



Pieds en caoutchouc, autocollants

Modèle	N°. de cde	Coloris	Remarque
GF	22009000	noir	Polyuréthane, 65-75 Shore

Fourniture: 4 pièces



Cache-vis

Modèle	N°. de cde
EM-SA	22080000

Fourniture: 6 cache-vis (polycarbonate)



Rail selon DIN EN 60715 TH 15

Modèle	N°. de cde	Remarque
TS 15	22150501	Pour EM/ET 206
TS 15	22150701	Pour EM/ET 207-210, EM/ET 225, B 1008..
TS 15	22150901	Pour EM/ET 212
TS 15	22151101	Pour EM/ET 213, EM/ET 215-217, EM/ET 227, B 1408.., B 1413..
TS 15	22151901	Pour EM/ET 214, EM/ET 221-223, EM/ET 232, EM/ET 237, BCD 200, B 2213..
TS 15	22151401	Pour EM/ET 218
TS 15	22151501	Pour EM/ET 220, EM/ET 229-231, EM/ET 238, B 1808.., B 1813..
TS 15	22152301	Pour EM/ET 224, EM/ET 233-236, EM/ET 239-242, B 2617.., B 2613.., B 2736.. (transversal)
TS 15	22152901	Pour EM/ET 247

Fourniture: 1 rail DIN

Euromas II

Accessoires

Rail selon DIN EN 60715 G 32

Modèle	N°. de cde	Remarque
TS 32	22320701	Pour EM/ET 208-210, EM/ET 225, B 1008..
TS 32	22320901	Pour EM/ET 212
TS 32	22321101	Pour EM/ET 213, EM/ET 215-217, EM/ET 227, B 1408.., B 1413..
TS 32	22321901	Pour EM/ET 214, EM/ET 221-223, EM/ET 232, EM/ET 237, B 22130.
TS 32	22321401	Pour EM/ET 218
TS 32	22321501	Pour EM/ET 220, EM/ET 229-231, EM/ET 238, B 1808.., B 1813..
TS 32	22322301	Pour EM/ET 224, EM/ET 233-236, EM/ET 239-242, B 2617.., B 2613.., B 2736.. (transversal)
TS 32	22322901	Pour EM/ET 247

Fourniture: 1 rail DIN



Rail selon DIN EN 60715 TH 35

Modèle	N°. de cde	Remarque
TS 35	22350701	Pour EM/ET 208-210, EM/ET 225, B 1008..
TS 35	22350901	Pour EM/ET 212
TS 35	22351101	Pour EM/ET 213, EM/ET 215-217, EM/ET 227, B 1408.., B 1413..
TS 35	22351901	Pour EM/ET 214, EM/ET 221-223, EM/ET 232, EM/ET 237, BCD 200, B 2213..
TS 35	22351401	Pour EM/ET 218
TS 35	22351501	Pour EM/ET 220, EM/ET 229-231, EM/ET 238, B 1808.., B 1813..
TS 35	22352301	Pour EM/ET 224, EM/ET 233-236, EM/ET 239-242, B 2617.., B 2613.., B 2736.. (transversal)
TS 35	22352901	Pour EM/ET 247

Fourniture: 1 rail DIN

